



# EC155 Power Control System

## 1 Key Features

150W (~12A) combined Power Converter / Battery Charger - Converts the 230V mains supply into 12v DC power to run the leisure equipment and charge the battery.

Low current switching reduces voltage drop in the circuit and improved circuit fusing provides better protection for the harness and equipment.

Links to the EC50 series LED Control Panel to provide simple but intelligent control of the 12v equipment and built in over discharge software protects the leisure and vehicle batteries.

## 2 System Overview

The following diagram shows the typical configuration of the EC155 system. The key component is the EC155 power supply unit (PSU), which is the hub of the system and provides connectivity to the ancillary components and the EC50 series control panel.

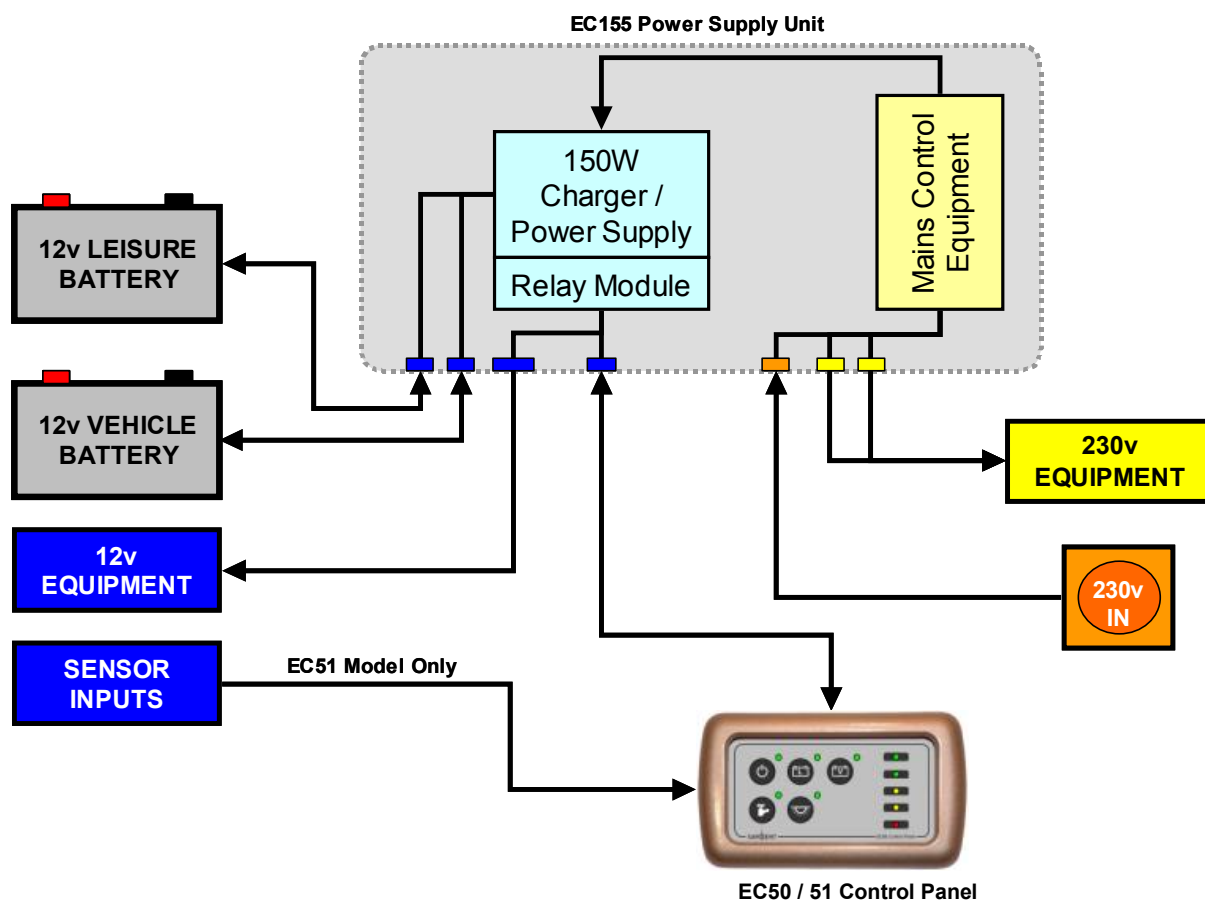



# EC155 Power Control System

## 3 Power Supply Details

For the safe operation of all electrical equipment within your Leisure Vehicle it is important that you read and fully understand these instructions. If you are unsure of any point please contact your dealer / distributor for advice before use.

The following diagram shows the EC155PSU layout.

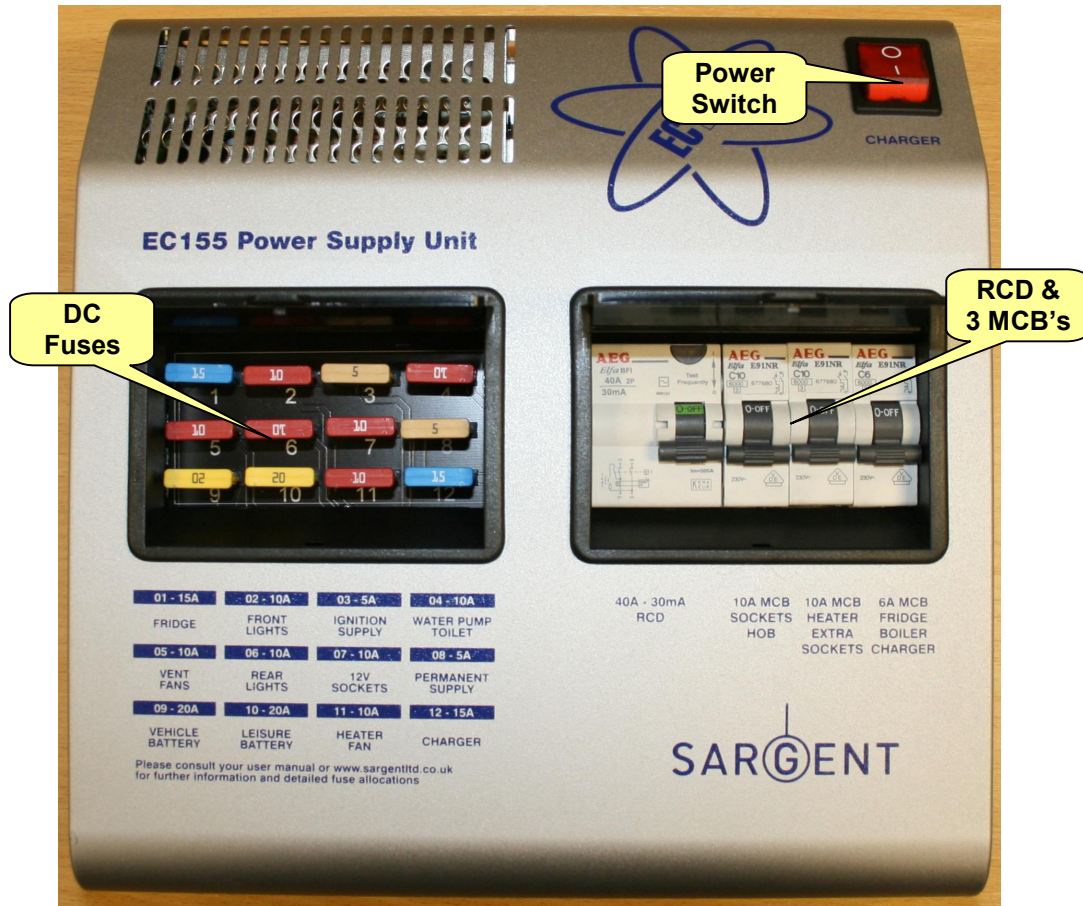

### WARNING

Under heavy loads the EC155PSU case may become hot. ALWAYS ensure the ventilation slots have a clear flow of air. Do not place combustible materials against / adjacent to the EC155PSU. The PSU will shutdown if overheated and will restart automatically when cool.

### 3.1 Battery Charger / Power Converter

The EC155PSU incorporates a fixed voltage battery charger / power converter. The battery charger / power converter also powers the leisure equipment when the mains supply is connected. This module supplies 13.8v DC to the leisure equipment up to a maximum of 12 Amps (155 Watts), therefore the available power is distributed between the leisure load and the battery, with the leisure load taking priority as per the following example:

Leisure load	Available power for battery charging
3A	9A
6A	6A
9A	3A
12A	0A



# EC155 Power Control System

## 3.2 Residual Current Device & Miniature Circuit Breakers

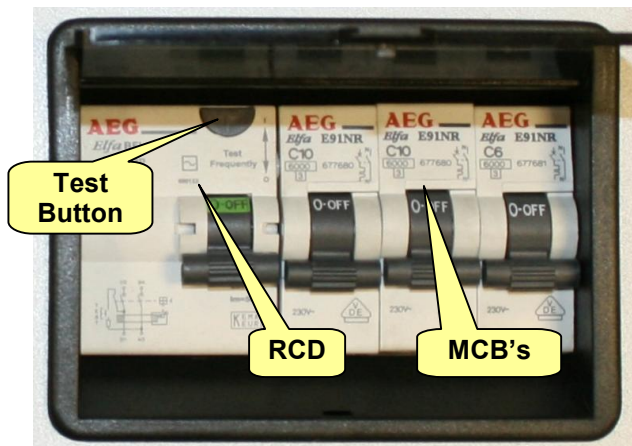

The Residual Current Device (RCD) is basically provided to protect the user from lethal electric shock. The RCD will turn off (trip) if the current flowing in the live conductor does not fully return down the neutral conductor, i.e. some current is passing through a person down to earth or through a faulty appliance.

To ensure the RCD is working correctly, the test button should be operated each time the vehicle is connected to the mains supply (see section 5.1)

The Miniature Circuit Breakers (MCB's) operate in a similar way to traditional fuses and are provided to protect the wiring installation from overload or short circuit. If an overload occurs the MCB will switch off the supply. If this occurs you should investigate the cause of the fault before switching the MCB back on.

The following table shows the rating and circuit allocation for the three MCB's

MCB	Rating	Wire Colour	Description
1	10 Amps	White	230v Sockets
2	10 Amps	White (Yellow for heater)	Extra 230v Sockets / Heater
3	6 Amps	Black (Blue for water heater)	Fridge / Water Heater / 12v Charger (internally connected)

## 3.3 Fuses

### WARNING

When replacing fuses always replace a fuse with the correct value. NEVER replace with a higher value / rating as this could damage the wiring harness. If a replacement fuse 'blows' do not keep replacing the fuse as you could damage the wiring harness. Please investigate the fault and contact your dealer.

The following table shows the fuse allocation for the 12 fuses fitted to the EC155PSU.

Fuse	Rating	Fuse Colour	Wire Colour	Description
1	15 Amps	Blue	Red / Yellow	Fridge
2	10 Amps	Red	Grey	Front Lights
3	5 Amps	Tan	Yellow/Green	Ignition Supplies
4	10 Amps	Red	Green / Blue	Water Pump / Toilet
5	10 Amps	Red	Black/Blue	Ventilation Fans
6	10 Amps	Red	Pink	Rear Lights
7	10 Amps	Red	Yellow / White	12v Sockets / TV Amplifier / Entertainment
8	5 Amps	Tan	Brown / Yellow	Permanent Supply (Radio / Fridge)
9	20 Amps	Yellow	Brown / Green	Vehicle Battery
10	20 Amps	Yellow	Brown / Blue	Leisure Battery
11	10 Amps	Red	Black/Red	Heater Fan
12	15 Amps	Blue	----	Charger

The following table shows details of the fuse(s) located at the Leisure battery.

Battery 1	20 Amps	Yellow	Brown / Blue	Fuse remotely located near battery
-----------	---------	--------	--------------	------------------------------------



# EC155 Power Control System

## 3.4 Battery

### A) Type / Selection

For optimum performance and safety it is essential that only a proprietary brand LEISURE battery is used with a typical capacity of 75 to 120 Ah (Ampere / hours). A normal car battery is NOT suitable. This battery should always be connected when the system is in use.

The EC155PSU is designed to charge standard lead acid leisure batteries, however it may be used with Gel batteries depending on their composition. Please consult the battery documentation for further advice.

The battery feed is fitted with an inline fuse between the battery and the electrical harness, and is usually located immediately outside the battery compartment or within 500mm of the battery. The maximum rating of this fuse is 20A per battery.

### B) Installation & Removal

Always disconnect the 230v mains supply and turn the EC155PSU charger switch to the OFF (0) position before removing or installing the battery.

When connecting the battery, ensure that the correct polarity is observed (black is negative [-] and red is positive [+]) and that the terminals are securely fastened. Crocodile clips must not be used.

### WARNING

Explosive gases may be present at the battery. Take care to prevent flames and sparks in the vicinity of the battery and do not smoke.

### C) Operation / Servicing

Under normal circumstances it should not be necessary to remove the battery other than for routine inspection of the terminals and “topping up” of the battery fluid where applicable. Please see instructions supplied with the battery.

Note: Do not over discharge the battery. One of the most common causes of battery failure is when the battery is discharged below the recommended level of approximately 10v. Discharging a battery below this figure can cause permanent damage to one or more of the cells within the battery.

To prevent over discharge, the EC155PSU in conjunction with the EC50 series control panel incorporates a battery protect circuit that warns and then disconnects the batteries when they fall below the following conditions:

Battery	Voltage cut off	Action after cut off	Notes
Vehicle	10.9v	Battery selection is changed from Vehicle battery to Leisure battery. If the leisure battery is below 9v then a further warning will occur (see below).	This cut off level is designed to protect the vehicle battery from over discharge. The 10.9v level ensures there is sufficient power in the battery to run the vehicle electronics and start the vehicle. This cut off only applies to power drawn from the battery by the leisure equipment; it will not protect the battery if you leave the vehicle lights on.
Leisure	9v	Power is turned off	This is an emergency cut off level to protect the battery from severe damage. You should not rely on this cut off level during normal operation, but manage your power consumption to a discharge level of 10v.  This cut off only applies to power drawn from the battery by the leisure equipment that is controlled by the control panel power switch; it will not protect the battery from discharge by the radio or other permanently connected equipment.



# EC155 Power Control System

## 4 Control Panel Details

### 4.1 Layout and Buttons

The following diagram shows the control panel layout and button functions (EC50 control panel).

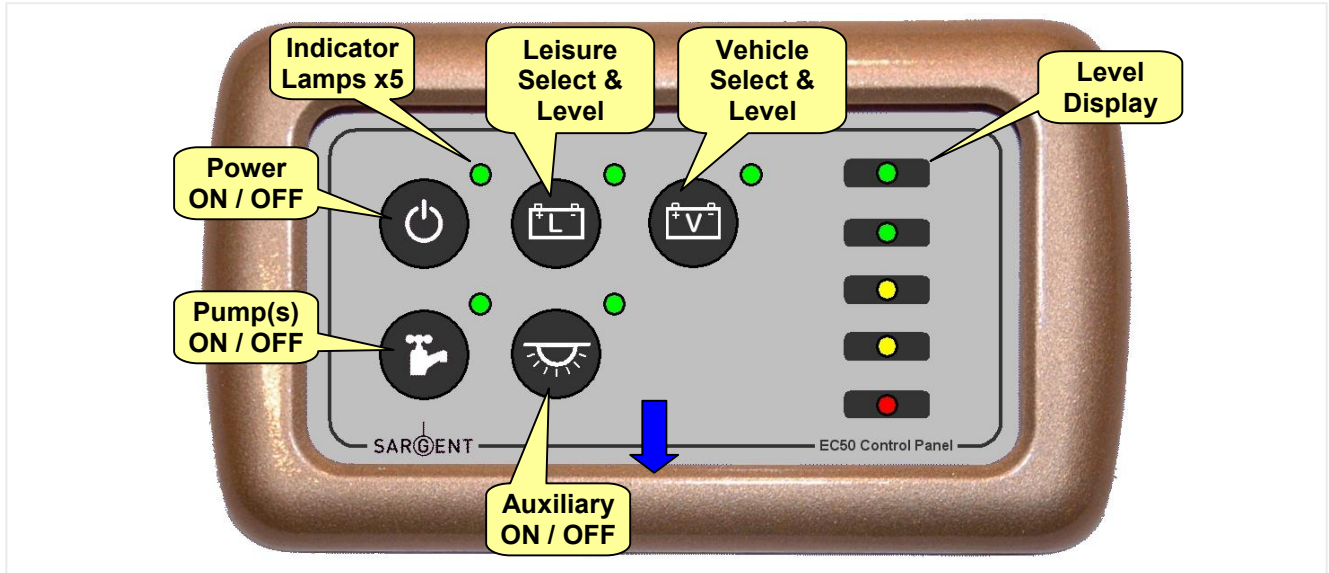

Note: to remove the decorative bezel, **pull down** and **lift forward** as indicated by the **blue** arrow.

### 4.2 Operation



Symbol	Function	Description
	Main 12v Power switch	This switch turns on (or off) the 12-volt power. As the power is turned on the Leisure battery is automatically selected and the LED display shows the battery voltage.
	Water Pump power switch	This switch turns on power to the internal water pump ready for use. It can be used to turn off the pump over night to avoid any noise from the pump. When the switch is on, the LED will show green.
	Auxiliary power switch	This switch turns the Awning or Entry light on (or off). When the switch is on the LED will show green.
	Select LEISURE battery and display battery voltage	This switch is used to select the Leisure battery and to display the battery voltage level. Press once to select and display the voltage. This display will turn off automatically after 5 seconds.  The LED next to the button will show that the battery has been selected.  If the Leisure battery drops below 9v an alarm will trigger to warn you that the battery is low. This alarm lasts for 1 minute and then the power will be switched off to protect the battery.
	Select VEHICLE battery and display battery voltage	This switch is used to select the Vehicle battery and to display the battery voltage level. Press once to select and display the voltage. This display will turn off automatically after 5 seconds.  The LED next to the button will show that the battery has been selected.  If the Vehicle battery drops below 10.9v an alarm will trigger to warn you that the battery is low. This alarm lasts for 1 minute and then the battery selection will automatically switch over to the Leisure battery to protect the vehicle battery.

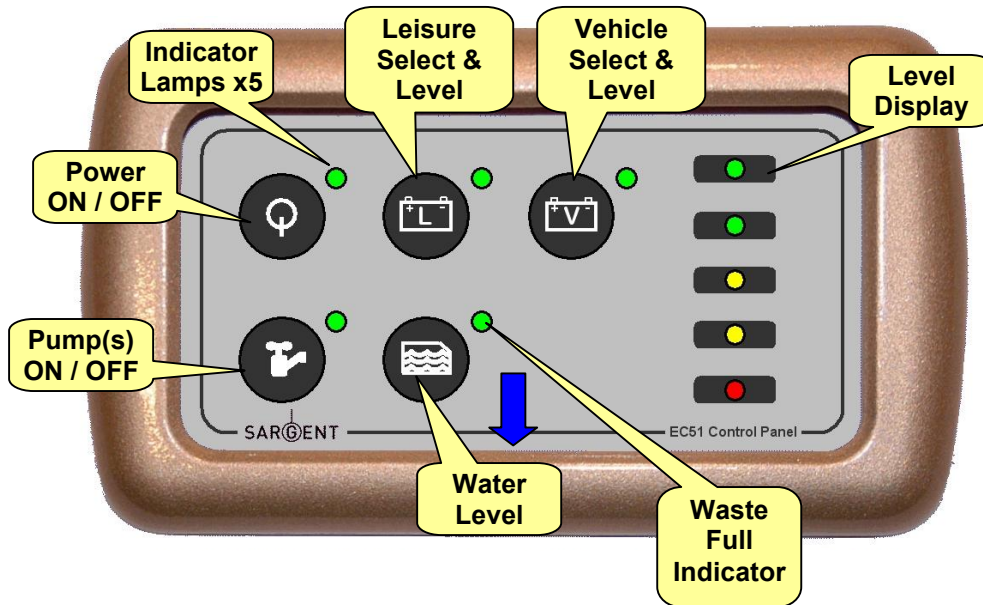

# EC155 Power Control System

EC51 version of the control panel with water level display



	<p>Water Level test</p>	<p>This switch is used to display the fresh water level within the onboard water tank. Press once to select the Fresh tank and show the water level. The tank has 5 levels Empty, ¼, ½, ¾ and Full. This display will turn off automatically after 5 seconds.</p>
	<p>Waste Full indicator</p>	<p>The LED adjacent to the water level button is used to show when the Waste Water Tank is full. The tank is full when the LED is illuminated.</p>



# EC155 Power Control System

## 4.3 System Disable

To meet EMC (Electro Magnetic Compatibility) directive 89/336/EEC the EC50 series control panel will shutdown, and the electrical accessories within the vehicle will be disconnected while the vehicle is in motion. When the engine is stopped the control panel returns to standby mode ready to be turned on by the power button.

## 4.4 Bar Graph Technical data

LED	Colour	Voltage reading	Water reading
5	Green	13.5 - 14.4	100% full
4	Green	12.5 - 13.5	75% full
3	Yellow	11.5 - 12.5	50% full
2	Yellow	10.5 - 11.5	25% full
1	Red	<= 10.5	Less than 25%

## 5 Operational & Safety Information

### 5.1 Connecting to the Mains supply - Safety checks

For your safety it is **IMPORTANT** that you follow these connections instructions each time your Leisure Vehicle is connected to a mains supply.

- A) **Ensure suitability of the Mains Supply.** Your Leisure Vehicle should only be connected to an approved supply that meets the requirements of BS7671. In most cases the site warden will hold information regarding suitability of supply. If using a generator you also need to comply with the requirements / instructions supplied with the generator. Please note that some electronic generators may not be compatible with your leisure system.
- B) **Switch the EC155PSU internal Power Converter OFF.** Locate the red 'Charger' power switch on the EC155PSU and ensure the switch is in the OFF (0) position before connection to the mains supply.
- C) **Connect the Hook-up Lead.** Firstly connect the supplied hook-up lead (orange cable with blue connectors) to the Leisure Vehicle and then connect to the mains supply.
- D) **Check Residual Current Device operation.** Locate the RCD within the EC155PSU and ensure the RCD is switched on (lever in up position). Press the 'TEST' button and confirm that the RCD turns off (lever in down position). Switch the RCD back to the on position (lever in up position). If the test button failed to operate the RCD see section 5.2.
- E) **Check Miniature Circuit Breakers.** Locate the MCB's within the EC155PSU (adjacent to the RCD) and ensure they are all in the ON (up) position. If any MCB's fail to latch in the on position see section 5.2.
- F) **Turn the EC155PSU ON.** Locate the red power switch on the EC155PSU and turn to the ON (I) position. The switch will illuminate when turned on.
- G) **Check operation of equipment.** It is now safe to check the operation of the 12v and 230v equipment.



# EC155 Power Control System

## 5.2 Common Fault Table

Fault	Possible Cause	Proposed Fix
No 230 volt output from PSU	Connecting lead between the site and Leisure Vehicle not connected	Check and connect lead as per 5.1C Check also input connector at the base of the EC155PSU
	RCD switched off	Reset RCD as per 5.1D
	RCD not operating correctly	Check supply polarity; if the RCD continues to fail contact your Dealer, as there is probably an equipment or wiring fault.
	MCB switched off	Reset MCB by switching OFF (down position) then back ON (up position), if the MCB continues to fail contact your Dealer, as there is probably an equipment or wiring fault.
	No or deficient supply from site	Contact site Warden for assistance
	Other fault	Contact your Dealer
Control Panel Problems	Control Panel has no display	Check batteries & fuses, turn EC155PSU charger switch on, and ensure mains supply is connected. Check control panel connecting lead at EC155PSU and behind Control Panel Contact your Dealer
	12v Power turns off	Battery save feature has operated to protect the Vehicle battery and or the Leisure battery. See 3.4C Engine has been started, all equipment has been disconnected to meet EMC requirements. See 4.3
	Control Panel display corrupt / erratic function	Observe control panel handling instructions Control panel software may have crashed. Reboot control panel by turning off the EC155PSU charger switch and removing fuses 9 & 10 at the EC155PSU (2x20A fuses for leisure and vehicle batteries). Wait 30 seconds then replace the fuses and turn the charger switch on. (Alternatively, remove the bezel at the control panel by pulling down in the centre at the bottom, unplug the control panel multi-way connector, wait 30 seconds, then plug back in and reassemble.)
No 12 volt output from PSU	No 230v supply	Check all above
	Charger not switched on	Switch charger switch on (I) position, switch will illuminate
	Battery not connected and / or charged	Install charged battery as per 3.4
	Power switch on control panel not switched to ON	Turn power on at control panel
	Battery flat / Battery fuse blown	Recharge battery, check fuses, check charging voltage is present at battery
	Fuse blown	Check all fuses are intact and the correct value fuse is installed as per fuse table
	Equipment switched off / unplugged	Check equipment is switched on and connected to the 12v supply
	PSU overheated / auto shutdown operated	Reduce load on system. Allow PSU to cool down. PSU will automatically restart when cool. See section 3
	Other fault	Contact your Dealer
Pump not working	Fuse blown	Replace fuse
	Pump turned off	Turn pump on by pressing the pump button at the EC155 control panel (tap symbol)





# EC155 Power Control System

## 6 Technical Data & Approvals

### 6.1 Outline Specification

INPUT 230v	230 Volts / 0 to 12 Amps	+ / - 10%
OUTPUT 230v	RCD protected, 3 x MCB outputs of 10, 10 and 6A via 2 x 9 way connectors	
INPUT 12v	2 x 20A battery inputs via a single 9 way connector	
OUTPUT 12v	20A total output via 4 x 16A switched channels protected by 12 fused outputs via a 12 way connector	
Integrated CHARGER	Input 220-240 Volts AC +/- 10%, Frequency 50 Hz +/- 6%, Current 3A max. DC Output 13.8 Volts nominal, Current 12 Amps max (155 Watts).	
Signal INPUT	1 x Engine running via PSU connector (4 x Fresh water level, 1 x Waste water level on EC51 version)	Fresh water negative sensed Waste water 5v sensed
Data IN / OUT	Data communication and power to Control Panel via 8 way RJ45 connector	
IP rating	IP31	
Operating temperature	Ambient 0 to 35° Centigrade PSU case temperature with full load 65° C Max	Automatic shutdown and restart if overheated / overloaded

### 6.2 Dimensions

EC155PSU	Overall size (HxWxD) 260 x 273 x 110mm	Fixing centres 262 x 224mm
	Clearances 75mm above, 20mm below, 50mm left & right	Weight 2.2 Kg
EC100 CONTROL PANEL	Overall size (HxWxD) 80 x 140 x 30mm	Fixing centres 123mm
	Cut-out size (HxW) 60 x 110mm	Weight 100 g

### 6.3 Approvals

System: BSEN 1648-1, BSEN1648-2 compliant, BS7671: 2008 compliant

Residual Current Device: RCD 40A 30mA trip to BS EN 61008

Miniature Circuit Breakers: MCB's (10 & 6A) type C 6000A breaking capacity to BSEN 60898

Electro Magnetic Compatibility (EMC) directive 89/336/EEC

Integrated Charger: BS EN 60335-1/2.29, 89/336/EEC, IEC61000-3.2/3:1995, EMC certificate 5172TC 3<sup>rd</sup> party tested.

### 6.4 Declaration of Conformity

*Equipment:* Leisure Power Control System

*Model name:* EC155PSU / EC50CP / EC51CP / EC52CP

I hereby declare that the equipment named above has been designed to comply with the relevant sections of the above referenced approvals. The unit complies with all essential requirements of the Directives.

<i>Signed:</i>	<i>Name:</i>	<i>Position:</i>	<i>Manufacturer:</i>
	I L Sargent	Technical Director	Sargent Electrical Services Ltd Unit 39, Tokenspire Business Park Woodmansey, Beverley East Yorkshire, United Kingdom
<i>Date:</i>			



# EC155 Power Control System

## 6.5 Electrical Connection

### A) Battery Input Connector

Pin	Function	Fuse	Wire Colour
1	Fridge 12V output	1	RED / YELLOW
2	Battery common earth 1	-	WHITE / ORANGE
3	Battery common earth 2	-	WHITE / ORANGE
4	Auxiliary 12V output	2	WHITE / ORANGE
5	Vehicle battery input 1	9	BROWN / GREEN
6	Vehicle battery input 2	9	BROWN / GREEN
7	Fridge power in / Engine run	-	RED
8	Leisure battery input 1	10	BROWN / BLUE
9	Leisure battery input 2	10	BROWN / BLUE

### B) 12v Output Connector

Pin	Function	Fuse	Wire Colour
1	Radio	11	BROWN / YELLOW
2	12v Sockets 1	7	YELLOW / WHITE
3	12v Sockets 2	7	YELLOW / WHITE
4	Ignitions	3	YELLOW / GREEN
5	Front Lights 1	2	SLATE
6	Front Lights 2	2	SLATE
7	Heater fan	11	BLACK / RED
8	Rear Lights 1	6	PINK
9	Rear Light 2	6	PINK
10	Fans	5	BLACK / BLUE
11	Toilet Pump	4	PURPLE
12	Pump	4	PURPLE / BLACK

### C) 230v Mains Input connector

Pin	Function	Wire Colour
1	Not used	-
2	Earth	GREEN / YELLOW
3	Live	BROWN
4	Neutral	BLUE

### D) 230v Mains output connector (2 off connectors wired identical)



## EC155 Power Control System

Pin	Function	MCB	Wire Colour
1	Live	3	BROWN
2	Earth	3	GREEN / YELLOW
3	Neutral	3	BLUE
4	Live	2	BROWN
5	Earth	2	GREEN / YELLOW
6	Neutral	2	BLUE
7	Live	1	BROWN
8	Earth	1	GREEN / YELLOW
9	Neutral	1	BLUE

1	2	3
4	5	6
7	8	9

While every effort has been made to ensure the accuracy and completeness of this document, no guarantee is given against errors or omissions. This document may be updated / improved over time therefore please check with your dealer / supplier for update information or visit [www.sargentltd.co.uk](http://www.sargentltd.co.uk)